

Ø 6mm ITEM NO: QX-6A

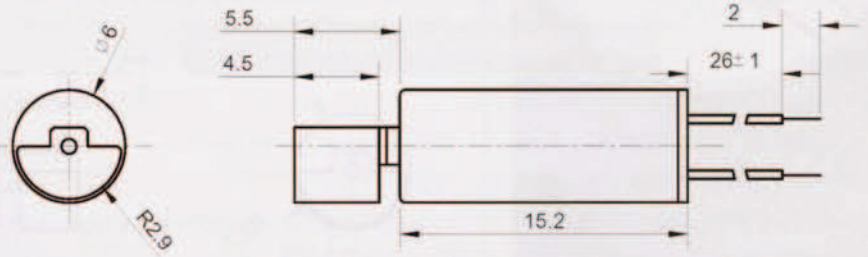

QX6A

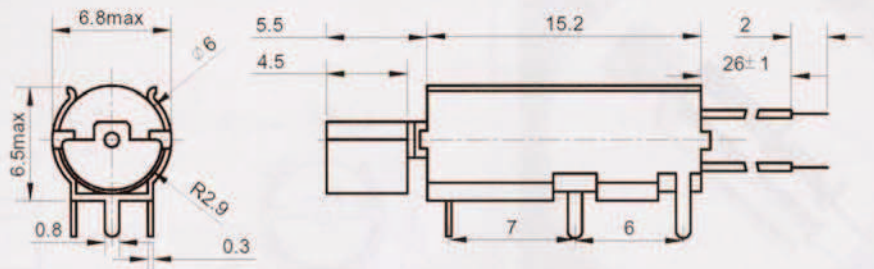
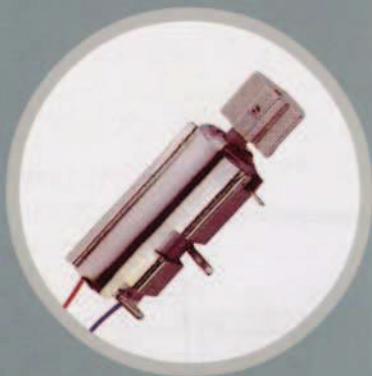

QX6A-1

型號 Model	額定電壓	電壓範圍	額定電流	額定轉速	起動電壓	堵轉電流	電樞電阻	軸向間隙	重量 (約)
	Rated voltage	Operating voltage	Rated current	Rated Speed	Starting Voltage	stall Current	Terminal Resistance	End play of Shaft	Weight(approx)
6A Series	V	V	mA	rpm	V	mA	Ω (approx)	mm	g
	1.3	0.9-1.6	80Max	9000 ±2000	0.8Max	155Max	9.2	0.1-0.2	3.3
	3	2.0-3.6	85Max	9500 ±2000	1.4Max	160Max	18	0.1-0.2	3.3

■ Specification of vibrator and holder can be designed according to customer's requirements
 振子規格和支架座可按顧客要求設定



Ø 6mm

ITEM NO:QX-6B

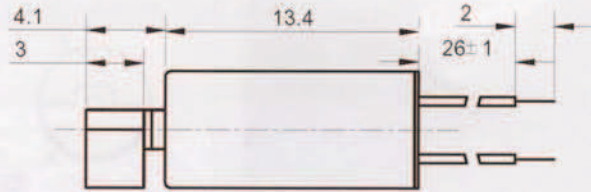

QX6B

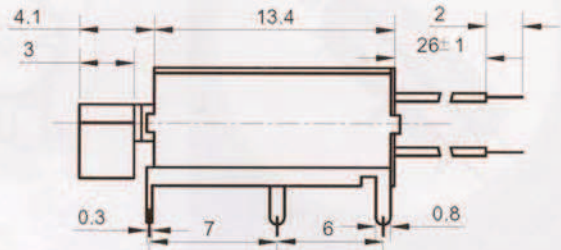
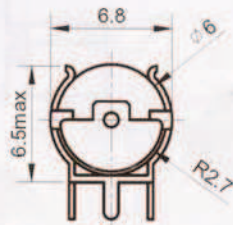
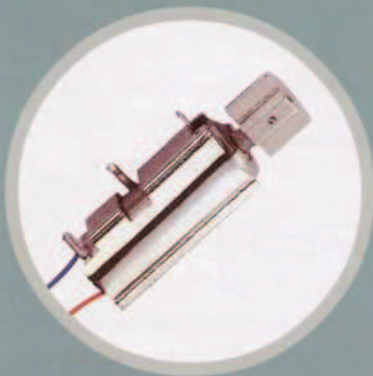

QX6B-J

型號 Model	額定電壓	電壓範圍	額定電流	額定轉速	起動電壓	堵轉電流	電樞電阻	軸向間隙	重量 (約)
	Rated voltage	Operating voltage	Rated current	Rated Speed	Starting Voltage	stall Current	Terminal Resistance	End play of Shaft	Weight(approx)
	V	V	mA	rpm	V	mA	Ω (approx)	mm	g
6B Series	1.3	0.9~1.6	80Max	8500 ±2000	0.8Max	150Max	10.0	0.1~0.2	2.6
	3	2.0~3.6	85Max	9500 ±2000	1.4Max	150Max	24.0	0.1~0.2	2.6

Specification of vibrator and holder can be designed according to customer's requirements

振子規格和支架座可按顧客要求設定

Ø 6mm ITEM NO: QX-6C

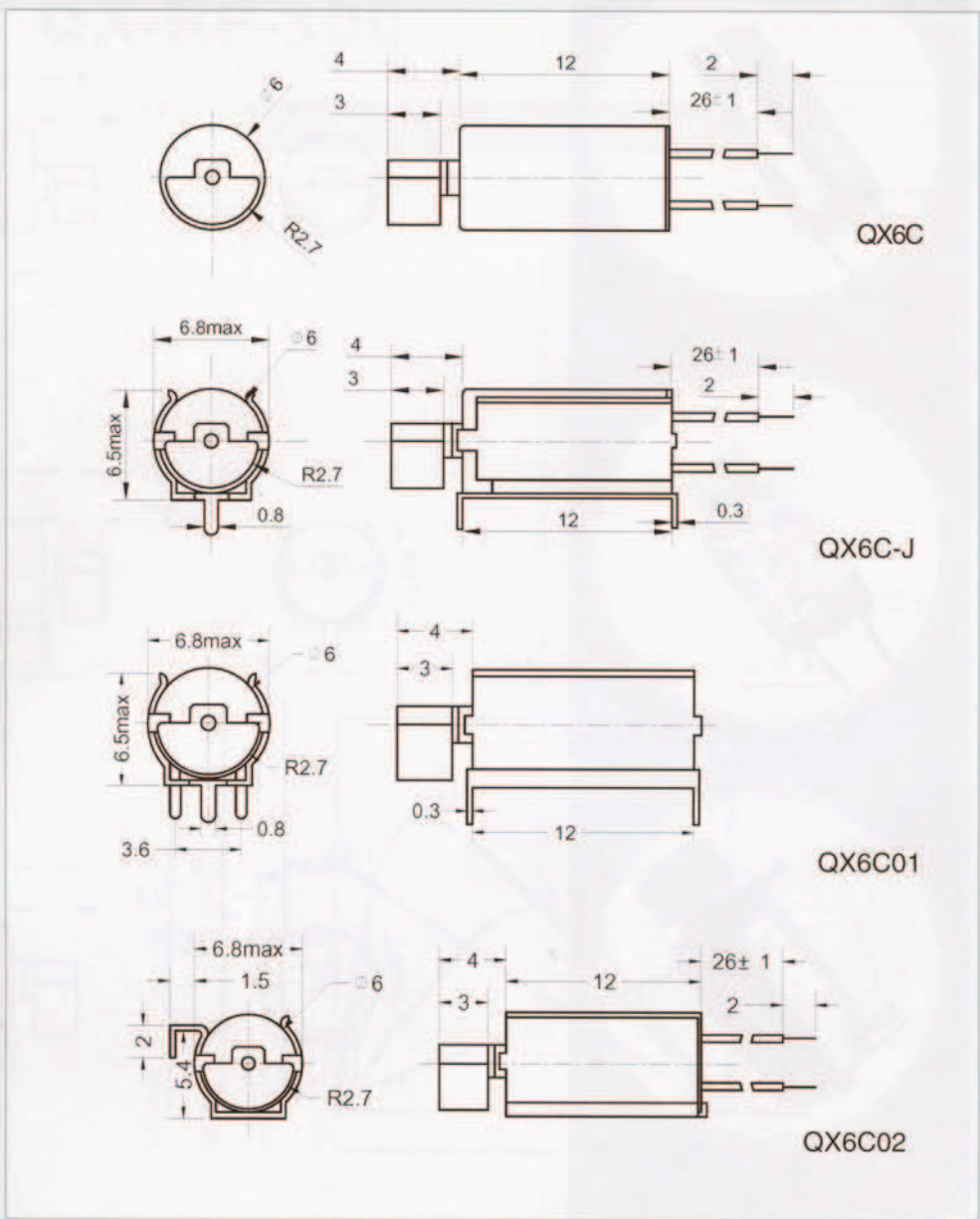
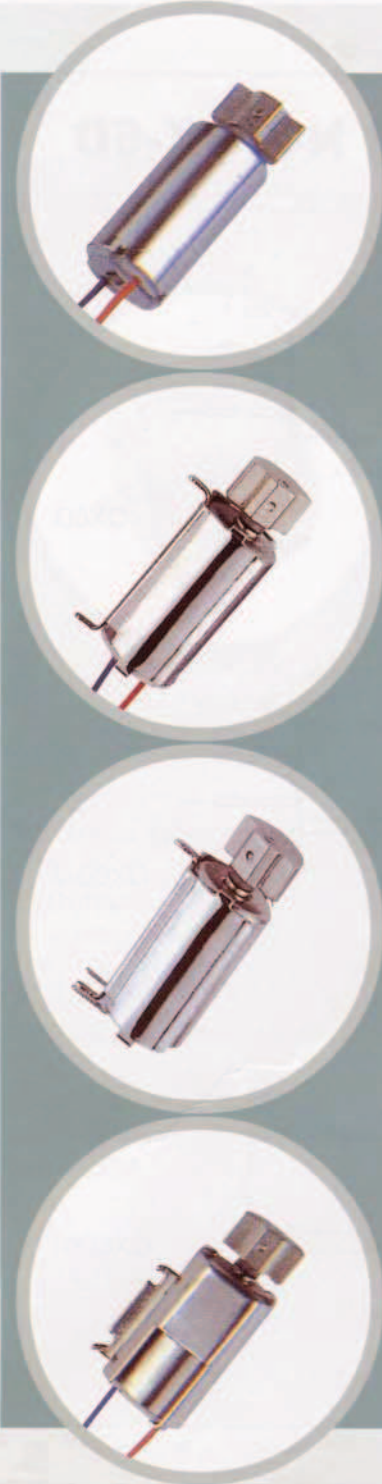

型號 Model	額定電壓	電壓範圍	額定電流	額定轉速	起動電壓	堵轉電流	電樞電阻	軸向間隙	重量(約)
	Rated voltage	Operating voltage	Rated current	Rated Speed	Starting Voltage	stall Current	Terminal Resistance	End play of Shaft	Weight(approx)
	V	V	mA	rpm	V	mA	Ω (approx)	mm	g
QX6C Series	1.3	0.9~1.6	75Max	10000 ±2500	0.85Max	150Max	10.0	0.1~0.2	2.4
	3	2.0~3.6	80Max	10000 ±2500	1.4Max	150Max	24.0	0.1~0.2	2.4

■ Specification of vibrator and holder can be designed according to customer's requirements
 振子規格和支架座可按顧客要求設定

Ø 6mm ITEM NO:QX-6D

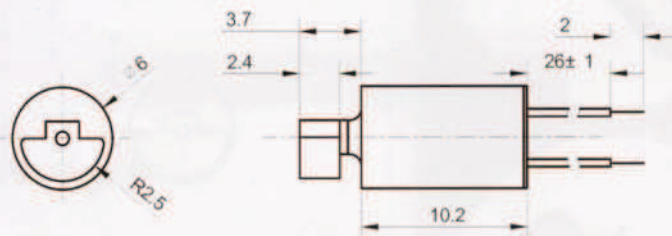

QX6D

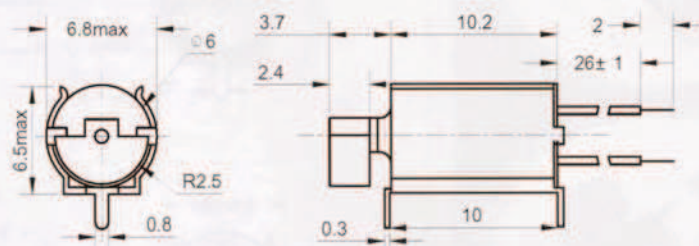

QX6D-J

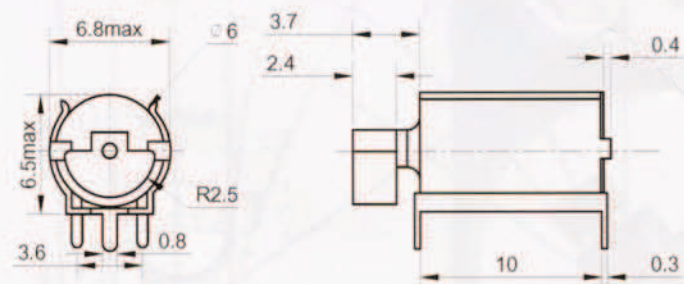

QX6D01

型號 Model	額定電壓	電壓範圍	額定電流	額定轉速	起動電壓	堵轉電流	電樞電阻	軸向間隙	重量 (約)
	Rated voltage	Operating voltage	Rated current	Rated Speed	Starting Voltage	stall Current	Terminal Resistance	End play of Shaft	Weight(approx)
	V	V	mA	rpm	V	mA	Ω (approx)	mm	g
QX6D Series	1.3	0.9~1.6	75Max	11000 ±2500	0.85Max	140Max	10.5	0.1~0.2	2
	3	2.0~3.6	85Max	16000 ±2000	1.4Max	135Max	24.0	0.1~0.2	2

■ Specification of vibrator and holder can be designed according to customer's requirements
 振子規格和支架座可按顧客要求設定