

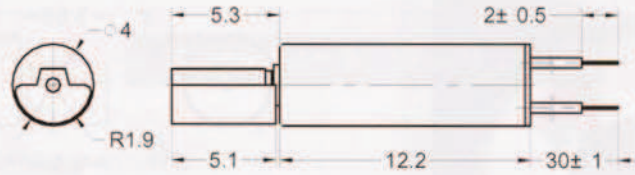

Ø 4mm ITEM NO:QX-4A

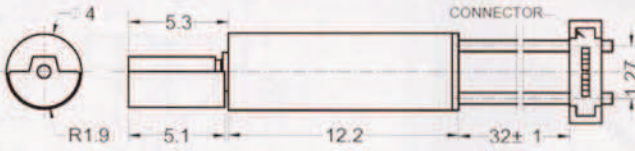

QX4A



QX4A-C

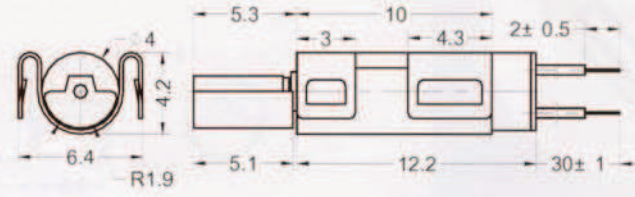

QX4A-J

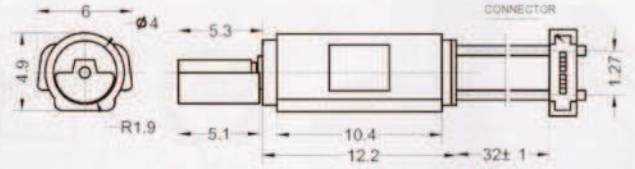

QX4A-C-H

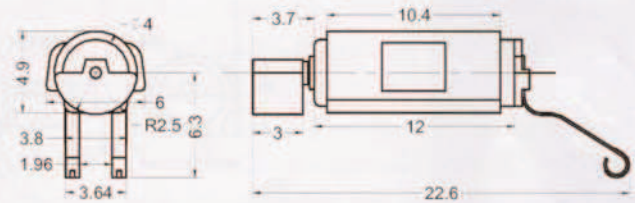

QX4A02-H

型號 Model	額定電壓 Rated voltage	電壓範圍 Operating voltage	額定電流 Rated current	額定轉速 Rated Speed	起動電壓 Starting Voltage	堵轉電流 stall Current	電樞電阻 Terminal Resistance	軸向間隙 End play of Shaft	重量(約) Weight(approx)
	V	V	mA	rpm	V	mA	Ω (approx)	mm	g
QX4A Series	1.3	0.9~1.6	80Max	10500 ±2500	0.9Max	120Max	14	0.1~0.2	1.2
	3	2.0~3.6	80Max	10500 ±2500	2.0Max	100Max	37	0.1~0.2	1.2

■ Specification of vibrator and holder can be designed according to customer's requirements
 振子規格和支架座可按顧客要求設定



Ø 4mm

ITEM NO:QX-4B

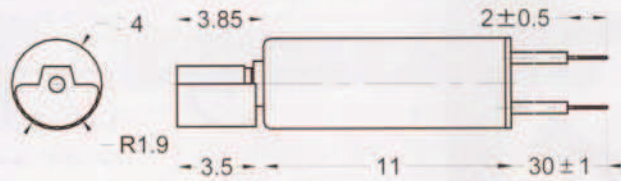

QX4B

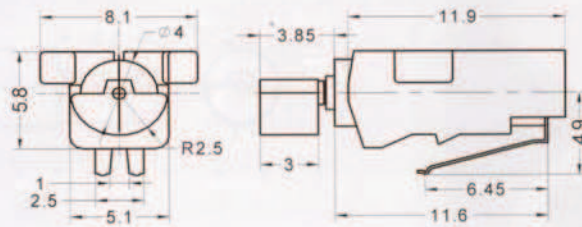

QX4B01-H

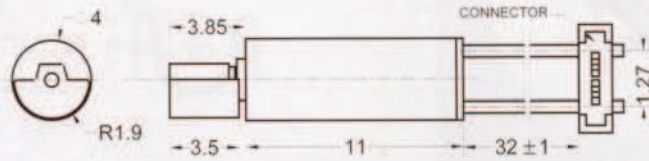

QX4B-C

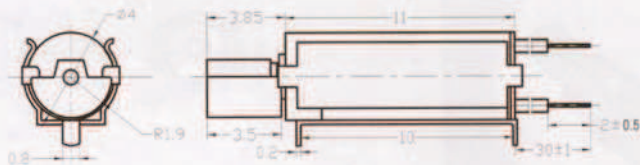

QX4B-J

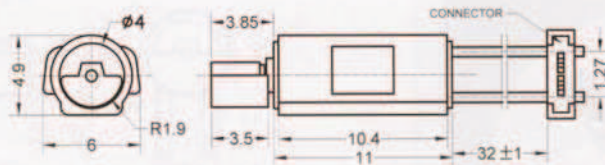

QX4B-C-H

型號 Model	額定電壓 Rated voltage	電壓範圍 Operating voltage	額定電流 Rated current	額定轉速 Rated Speed	起動電壓 Starting Voltage	堵轉電流 stall Current	電樞電阻 Terminal Resistance	軸向間隙 End play of Shaft	重量 (約) Weight (approx)
	V	V	mA	rpm	V	mA	Ω (approx)	mm	g
QX4B Series	1.3	1.0~1.6	80Max	10500 ±2500	1.0Max	120Max	12	0.1~0.2	1.1
	3	2.0~3.6	80Max	11500 ±2500	2.0Max	100Max	34	0.1~0.2	1.1

■ Specification of vibrator and holder can be designed according to customer's requirements.

振子規格和支架座可按顧客要求設定

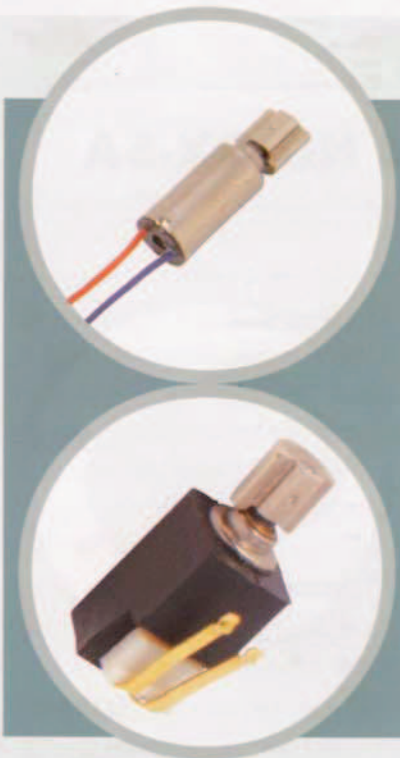
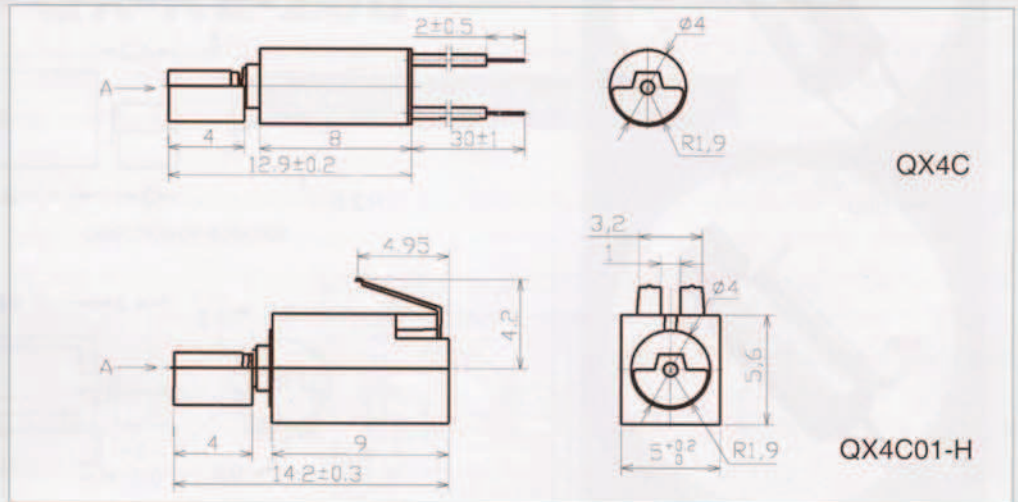
Ø4mm
ITEM NO:QX-4C

QX4C
QX4C01-H

型號 Model	額定電壓 Rated voltage	電壓範圍 Operating voltage	額定電流 Rated current	額定轉速 Rated Speed	起動電壓 Starting Voltage	堵轉電流 stall Current	電樞電阻 Terminal Resistance	軸向間隙 End play of Shaft	重量(約) Weight(approx)
	V	V	mA	rpm	V	mA	Ω (approx)	mm	g
4C系列 4C Series	1.5	1.2~1.8	140Max	13000±3000	1.0Max	170Max	10	0.1~0.2	1.1
	3	2.0~3.6	120Max	13000±3000	2.0Max	135Max	25	0.1~0.2	1.1

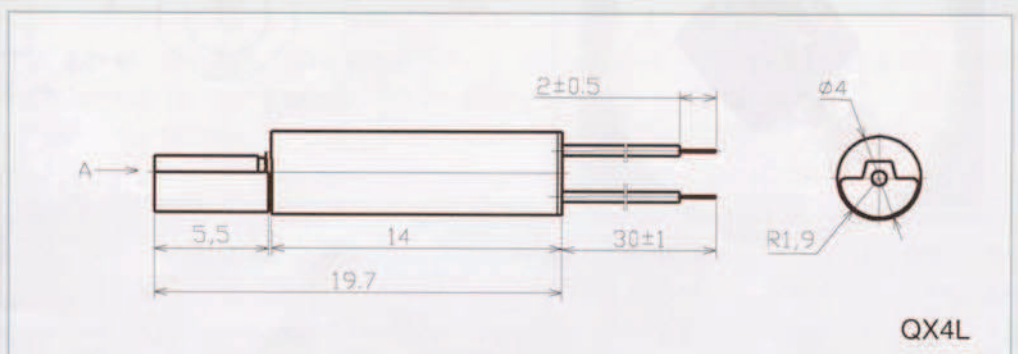
■ Specification of vibrator and holder can be designed according to customer's requirements
 振子規格和支架座可按顧客要求設定

Ø4mm
ITEM NO:QX-4L

QX4L

型號 Model	額定電壓 Rated voltage	電壓範圍 Operating voltage	額定電流 Rated current	額定轉速 Rated Speed	起動電壓 Starting Voltage	堵轉電流 stall Current	電樞電阻 Terminal Resistance	軸向間隙 End play of Shaft	重量(約) Weight(approx)
	V	V	mA	rpm	V	mA	Ω (approx)	mm	g
4L系列 4L Series	1.3	0.9~1.6	80Max	10500 ±2500	0.85Max	120Max	14	0.1~0.2	1.3
	3	2.0~3.6	80Max	10500 ±2500	2.0Max	100Max	37	0.1~0.2	1.3

■ Specification of vibrator and holder can be designed according to customer's requirements
 振子規格和支架座可按顧客要求設定