

5mm Green Round LED Lamp with Blue diffused Lens

P/N.: LL50PGD90-3000

·Package Dimensions

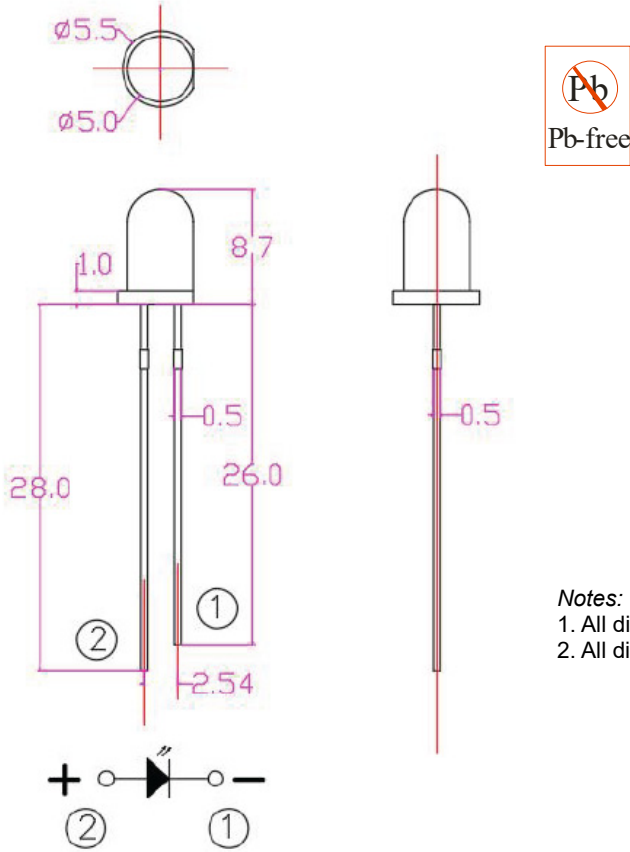

Notes:
 1. All dimension units are millimeters.
 2. All dimension tolerance is ± 0.25 mm

·Application

- Backlight
- Lighting
- Indicator light

·Product Description

- Appearance dimensions: 5mm Round
- Anti-static bag packaging
- Suitable for wave soldering process
- Colloidal color: Green diffused
- Luminous color: Green
- Half power view: 90°

·Absolute Maximum Ratings (Ta=25C°)

Item	Symbol	Maximum	Unit
Power Dissipation	Pd	100	mW
Peak Forward Current (1/10 Duty Cycle 0.1ms Pulse Width)	I _{FP}	50	mA
Forward Current	I _{Fmax}	20	mA
Reverse Voltage	V _R	5	V
Operating Temperature Range	Topr	-20 to+85°C	
Storage Temperature Range	Tstg	-40 to+85°C	

·Electrical / Optical Characteristics (Ta=25C°)

Item	Symbol	Min.	Typ.	Max.	Unit	Condition
Luminous intensity	I _v	3000	--	4000	mcd	I _F =20mA
Dominant wavelength	λ _d	520	--	530	nm	I _F =20mA
Peak wavelength	λ _p	--	527	--	nm	I _F =20mA
Spectrum radiation bandwidth	Δλ	--	30	--	nm	I _F =20mA
Forward Voltage	V _F	3.0	--	3.2	V	I _F =20 mA
Reverse Current	I _R	-	-	10	μ A	V _R =5V
Half power view	2θ _{1/2}	--	90	--	deg	I _F =20 mA

NOTES:

- 1.All dimensions are in millimeter(inch).
- 2.Tolerance is ±0.25mm (0.01") unless other specified; Luminous intensity tolerance is ±10%.
- 3.Dominant Emission Wavelength tolerance is ±1nm; Specifications are subject to change without notice.

Typical Electro-Optical Characteristic Curve

FIG. 1 Forward Current Vs. Forward Voltage

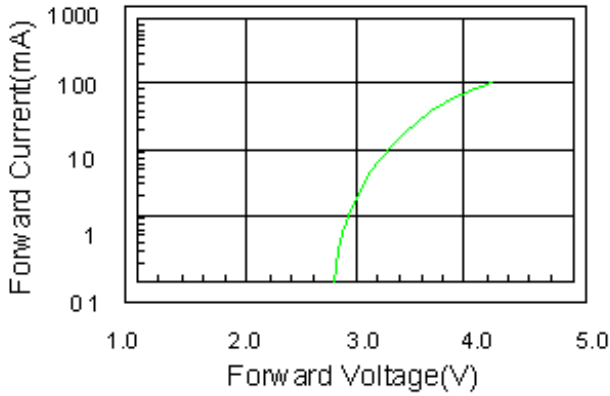

FIG. 2 Relative Intensity Vs. Forward Current

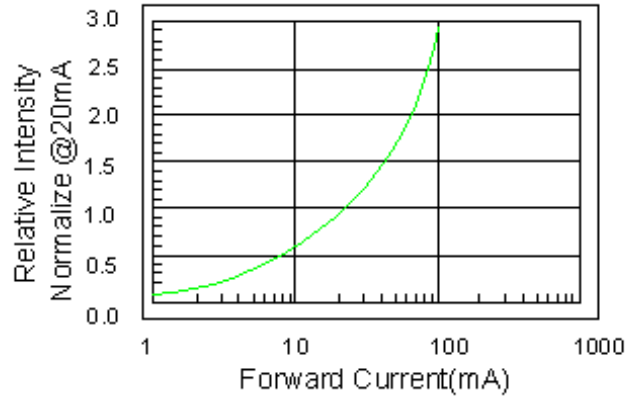

FIG. 3 Forward Voltage Vs. Temperature

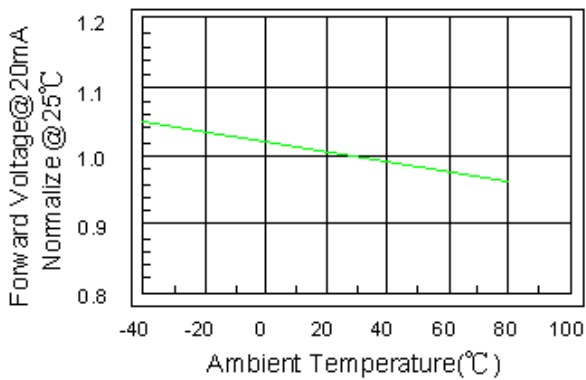

FIG. 4 Relative Intensity Vs. Temperature

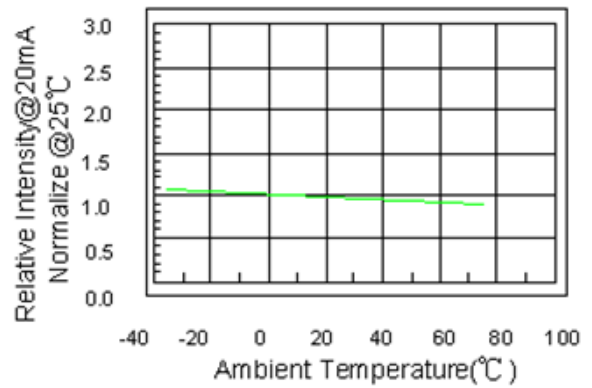
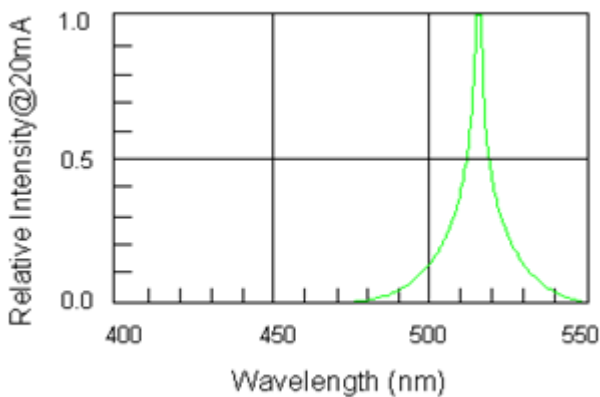

FIG. 5 Relative Intensity Vs. Wavelength



Instruction manual of through-hole LED lamp

·Soldering condition

Manual soldering		Solder Dipping	
Soldering iron	30W max	Preheat	100°C max
Temperature	300°C max	Preheat time	60 seconds max
		Solder-bath temperature	240°C max
Soldering time	3 seconds max	Dipping time	2 seconds max
Position	Not less than 3mm from the base of the package	Position	Not less than 3mm from the base of the package

Manual soldering onto the PCB is not recommended because soldering time is uncontrollable.

The recommended wave soldering is as below:

Lead Soldering Temperature/Time	240°C/≤3S, Not less than 3mm from the base of the package.
---------------------------------	------------------------------------------------------------

·Pin forming method

- 2 mm from collate is required to bend the bracket.
- Bracket forming must be done with a fixture or by a professional.
- Bracket forming must be done before welding.
- Bracket forming needs to ensure that the pins and spacing are consistent with the circuit board.

·LED installation method

- Please pay attention to the arrangement of the external lines of various types of devices, in order to prevent polarity from being misplaced. The device must not be too close to the heating element and the working conditions should not exceed its specified limits.
- Be sure not to install led in the case of pin deformation.
- When deciding to install in the hole, calculate the dimensions and tolerances of the face and the pitch of the hole on the circuit board to avoid excessive pressure on the bracket.
- When installing LEDs, the construction of a guide set positioning.
- Before the welding temperature returns to normal, the LED must be avoided by any vibration or external force.

·Storage conditions

- Prevent continued exposure to the condensing moisture environment and keep the product away from rapid transitions in ambient temperature.
- LEDs should be stored with temperature ≤30°C and relative humidity ≤60%。
- Product in the original sealed package is recommended to be assembled within 72 hours of opening. Product in opened package for more than a week should be baked for 30 (+10/-0) hours at 85-100°C.

Others

1. The lead pitch of the LED must match the pitch of the mounting holes on the PCB during component. Lead-forming may be required to insure the lead pitch matches the pitch. Refer to the figure below for proper lead forming procedures. (Fig.①)

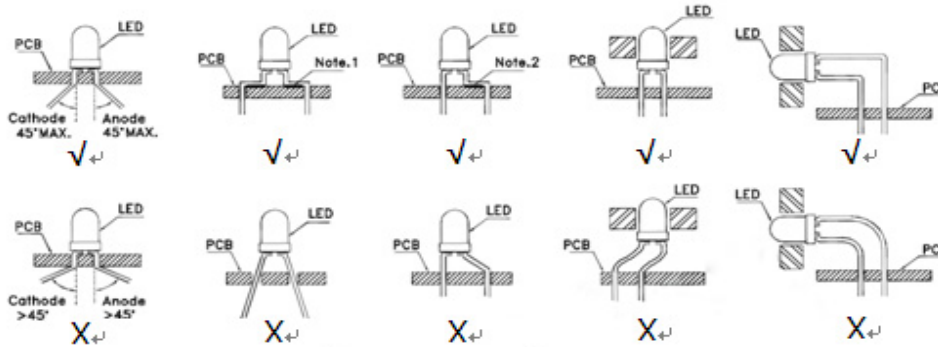

3. Fig.① Use stand-offs (fig.②) or spacers (fig.③) to securely position the LED above the PCB.

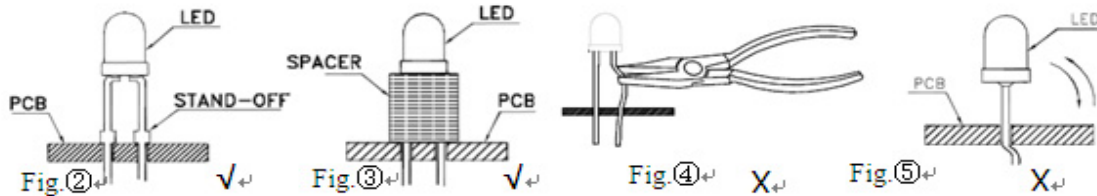

2. During lead forming, use tools or jigs to hold the leads securely so that the bending force will not be transmitted to the LED lens and its internal structures. Do not perform lead forming once the component has been mounted onto the PCB.(fig.④)

3. Do not bend the leads more than twice. (fig.⑤)

4. During soldering, component covers and holders should leave clearance to avoid placing damaging stress on the LED during soldering

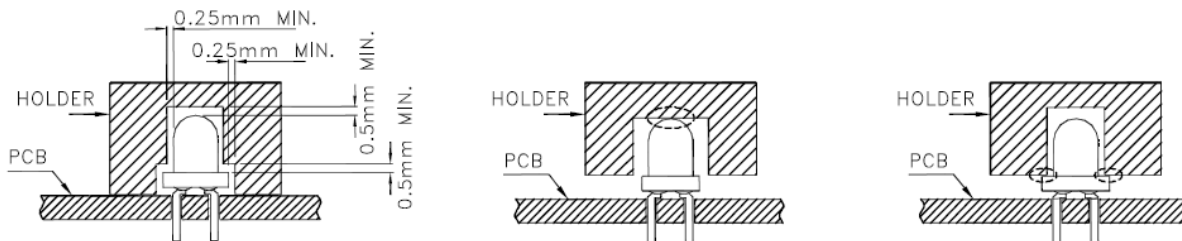

These specification sheets include materials protected under copyright of LITEKEY COMPANY LIMITED. Please don't reproduce cause by anyone to reproduce them without LITEKEY's consent.