

# Power PCB Relay G6B

## Subminiature Relay that Switches up to 5 A

- Subminiature: 20 x 10 x 10 mm (L x W x H).
- Low power consumption: 200 mW.
- Unique moving loop armature reduces relay size, magnetic interference, and contact bounce time.
- Fully sealed construction
- Single and Dual coil latching types also available.
- High Capacity versions available
- RoHS Compliant

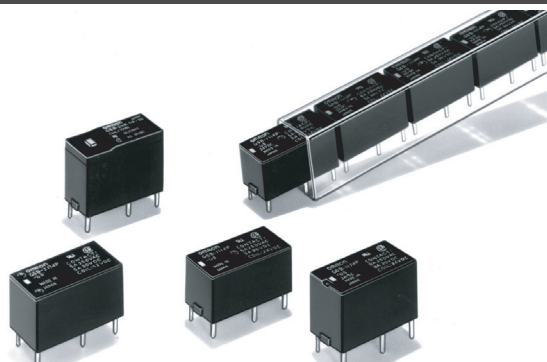

## Ordering Information

Classification	Contact form	Straight Through-hole PCB	Self-clinching Through-hole PCB
Non-latching	SPST-NO	G6B-1114P-US	G6B-1114C-US
	SPST-NO+SPST-NC	G6B-2114P-US	G6B-2114C-US
	DPST-NO	G6B-2214P-US	G6B-2214C-US
	DPST-NC	G6B-2014P-US	G6B-2014C-US
Single coil latching	SPST-NO	G6BU-1114P-US	G6BU-1114C-US
Dual coil latching	SPST-NO	G6BK-1114P-US	G6BK-1114C-US
High-capacity, Non-latching	SPST-NO	G6B-1174P-US	G6B-1174C-US

**Note:** When ordering, add the rated coil voltage to the model number.

Example: G6B-1114P-US DC12

Rated coil voltage

## Model Number Legend

G6B    -          -    -    DC   

1    2    3    4    5    6    7    8

### 1. Relay Function

- None: Non-latching
- U: Single coil latching
- K: Dual coil latching

### 2. Contact Form

- 21: SPST-NO + SPST-NC
- 22: DPST-NO
- 20: DPST-NC
- 11: SPST-NO

### 3. Contact Type

- 1: Standard
- 7: High-capacity

### 4. Enclosure Ratings

- 4: Fully sealed

### 5. Terminals

- P: Straight Through-hole PCB
- C: Self-clinching Through-hole PCB

### 6. Approved Standards

- US: UL/CSA certified

### 7. Mounting Method

- None: Mount directly to PCB
- P6B: Mount to Socket

### 8. Rated Coil Voltage

- 5, 6, 12, or 24 VDC

## ■ Accessories (Order Separately)

### Back Connecting Sockets

Applicable Relay	Back Connecting Socket (See note 1.)
G6B(U)-1114P-US-P6B	P6B-04P
G6BK-1114P-US-P6B	P6B-06P
G6B-2□□4P-US-P6B	P6B-26P
G6B-1174P-US-P6B	P6B-04P

- Note:** 1. Not applicable to the self-clinching type.  
 2. Use the G6B-□□□□P-US-**P6B** if mounting relays in a P6B Socket.

Removal Tool	P6B-Y1
Hold-down Clips	P6B-C2

## Specifications

### ■ Contact Ratings

Item	SPST-NO		SPST-NO + SPST-NC, DPST-NO, DPST-NC	
	Resistive load ( $\cos\phi = 1$ )	Inductive load ( $\cos\phi = 0.4$ ; L/R = 7 ms)	Resistive load ( $\cos\phi = 1$ )	Inductive load ( $\cos\phi = 0.4$ ; L/R = 7 ms)
Rated load	5 A at 250 VAC; 5A at 30 VDC	2 A at 250 VAC; 2 A at 30 VDC	5 A at 250 VAC; 5A at 30 VDC	1.5 A at 250 VAC; 1.5 A at 30 VDC
Contact material	Ag Alloy (Cd free)			
Rated carry current	5 A			
Max. switching voltage	380 VAC, 125 VDC			
Max. switching current	5 A			
Max. switching capacity	1,250 VA, 150 W	500 VA, 60 W	1,250 VA, 150 W	375 VA, 80 W
Min. permissible load (reference value - see note)	10 mA at 5 VDC			

Item	SPST-NO (High-capacity)	
Load	Resistive load ( $\cos\phi = 1$ )	Inductive load ( $\cos\phi = 0.4$ ; L/R = 7 ms)
Rated load	8 A at 250 VAC; 8 A at 30 VDC	2 A at 250 VAC; 2 A at 30 VDC
Contact material	Ag Alloy (Cd free)	
Rated carry current	8 A	
Max. switching voltage	380 VAC, 125 VDC	
Max. switching current	8 A	
Max. switching capacity	2,000 VA, 150 W	
Min. permissible load (reference value - see note)	10 mA at 5 VDC	

**Note:** P level:  $\lambda_{60} = 0.1 \times 10^{-6}$ /operation

### ■ Coil Ratings

#### Non-latching, Single Pole

Rated voltage (VDC)	Rated current (mA)	Coil resistance ( $\Omega$ )	Coil inductance (ref. value)(H)		Pick-up voltage	Dropout voltage	Max. voltage	Power consumption (mW)
			Armature OFF	Armature ON				
5	40	125	0.28	0.26	70% max.	10% min.	160% max. @ 23°C	Approx. 200
6	33.30	180	0.31	0.28				
12	16.70	720	1.2	1.1				
24	8.30	2,880	4.9	4.1				

- Note:** 1. The rated current and coil resistance are measured at a coil temperature of 23°C with a tolerance of  $\pm 10\%$ .  
 2. Operating characteristics are measured at a coil temperature of 23°C.

### Non-latching, Double Pole

Rated voltage (VDC)	Rated current (mA)	Coil resistance (Ω)	Pick-up voltage	Dropout voltage	Max. voltage	Power consumption (mW)
			% of rated voltage			
5	60	83.30	80% max.	10% min.	140% max. @ 23°C	Approx. 300
6	50	120				
12	25	480				
24	12.50	1,920				

### Single Coil Latching

Rated voltage (VDC)	Rated current (mA)	Coil resistance (Ω)	Coil inductance (ref. value) (H)		Set pick-up voltage	Reset pick-up voltage	Maximum voltage	Power consumption (mW)
			Armature OFF	Armature ON	% of rated voltage			
5	40	125	0.28	0.26	70% max.	70% max.	160% max. at 23°C	Approx. 200
6	33.30	180	0.31	0.28				
12	16.70	720	1.2	1.10				
24	8.30	2,880	4.9	4.10				

### Dual Coil Latching

Rated voltage (VDC)	Rated current (mA)	Coil resistance (Ω)	Coil inductance (ref. value) (H)		Set pick-up voltage	Reset pick-up voltage	Maximum voltage	Power consumption (mW)
			Armature OFF	Armature ON	% of rated voltage			
5	56	89.20	0.15	0.15	70% max.	70% max.	130% max. at 23°C	Approx. 280
6	46.80	128.50	0.18	0.18				
12	23.30	515	0.52	0.52				
24	11.70	2,060	1.20	1.20				

**Note:** 1. The rated current and coil resistance are measured at a coil temperature of 23°C with a tolerance of ±10%.  
 2. Operating characteristics are measured at a coil temperature of 23°C.

## ■ Characteristics

<b>Contact resistance</b>		30 mΩ max.
<b>Operate (set) time</b>		10 ms max. (mean value: 1-pole approx. 3 ms, 2-pole approx. 4 ms)
<b>Release (reset) time</b>	<b>Non-latching</b>	10 ms max. (mean value: 1-pole approx. 1 ms, 2-pole approx. 2 ms)
	<b>Latching</b>	10 ms max. (mean value: approx. 3 ms)
<b>Min. set/reset signal width</b>		Latching type: 15 ms min. (at 23°C)
<b>Max. operating frequency</b>	<b>Mechanical</b>	18,000 operations/hr
	<b>Electrical</b>	1,800 operations/hr (under rated load)
<b>Insulation resistance</b>		1,000 MΩ min. (at 500 VDC, at 250 VDC between set coil and reset coil)
<b>Dielectric strength</b>		3,000 VAC (Latching types: 2,000 VAC), 50/60 Hz for 1 min between coil and contacts 1,000 VAC, 50/60 Hz for 1 min between contacts of same polarity 250 VAC, 50/60 Hz for 1 min between set and reset coils 2,000 VAC, 50/60 Hz for 1 min between contacts of different polarity
<b>Vibration resistance</b>	<b>Mechanical durability</b>	10 to 55 Hz, 1.5-mm double amplitude
	<b>Malfunction durability</b>	10 to 55 Hz, 1.5-mm double amplitude
<b>Shock resistance</b>	<b>Mechanical durability</b>	1,000 m/s <sup>2</sup> (Approx 100G)
	<b>Malfunction durability</b>	Single-side stable: 100 m/s <sup>2</sup> (Approx 10G); Latching: 300 m/s <sup>2</sup> (Approx 30G)
<b>Service Life</b>	<b>Mechanical</b>	50,000,000 operations min. (at 18,000 operations/hr)
	<b>Electrical</b>	100,000 operation min. (at 1,800 operations/hr)
<b>Ambient temperature</b>		Operating: -25°C to 70°C (with no icing)
<b>Ambient humidity</b>		Operating: 5% to 85%
<b>Weight</b>		Double-winding latching: Approx. 3.7 g High-capacity: Approx. 4.6 g Double pole: Approx. 4.5 g Other: Approx. 3.5 g

**Note:** The data shown above are initial values.

## Approved Standards

UL Recognized (File No. E41643) / CSA Certified (File No. LR31928)

Model	Contact form	Coil rating	Contact rating
G6B-1114P-US G6B-1114C-US G6BU-1114P-US G6BU-1114C-US G6BK-1114C-US G6BK-1114C-US	SPST-NO	3 to 24 VDC	5 A at 250 VAC (General Use) 80°C 5 A at 30 VDC (Resistive) 80°C
G6B-1174P-US G6B-1174C-US			8 A at 250 VAC (General Use) 80°C 8 A at 30 VDC (Resistive) 80°C
G6B-2114P-US G6B-2114C-US G6B-2214P-US G6B-2214C-US G6B-2014P-US G6B-2014C-US	SPST-NO + SPST-NC DPST-NO DPST-NC		5 A at 250 VAC (general use) 40°C 5 A at 30 VDC (resistive load) 40°C

## Engineering Data

### G6B-1114P-US

#### Maximum Switching Capacity

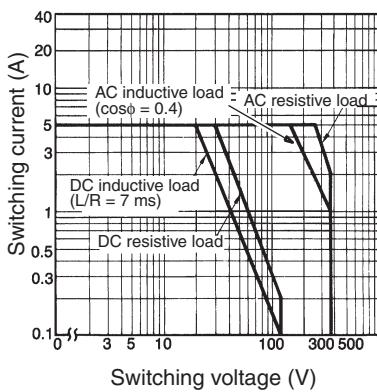

#### Electrical Service Life

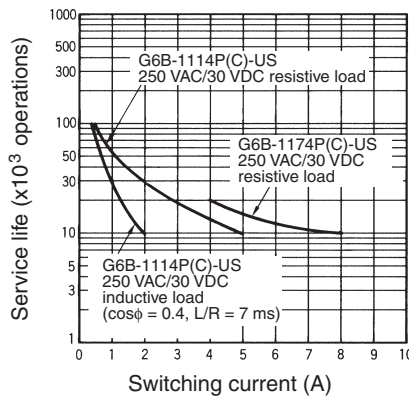

#### Ambient Temperature vs. Maximum Coil Voltage

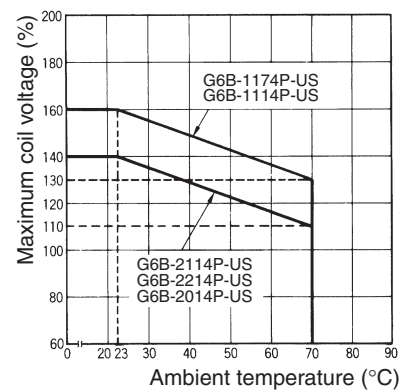

**Note:** The maximum coil voltage refers to the maximum value in a varying range of operating power voltage, not a continuous voltage.

### G6B-2114P-US, G6B-2214P-US, G6B-2014P-US

#### Maximum Switching Capacity

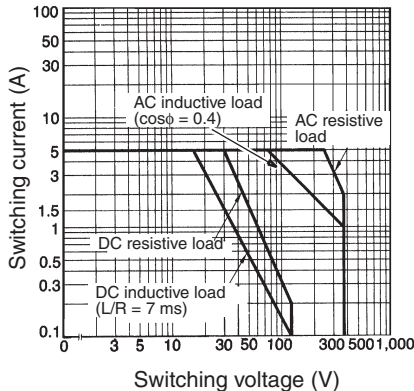

#### Electrical Service Life

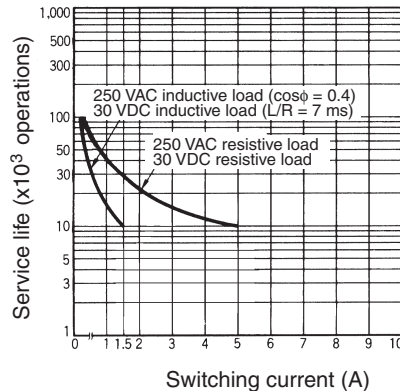

# Dimensions

Note: 1. All units are in millimeters unless otherwise indicated.

2. Orientation marks are indicated as follows:

## Single Pole

**G6B-1114P-US**  
**G6BU-1114P-US**

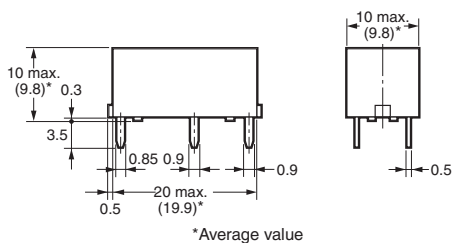
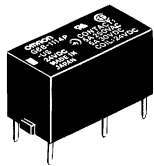

**Terminal Arrangement/Internal Connections (Bottom View)**  
**G6B-1114P, -1114C**

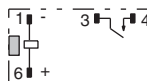

**Mounting Holes (Bottom View)**  
**G6B-1114P, -1114C**  
**G6BU-1114P, -1114C**

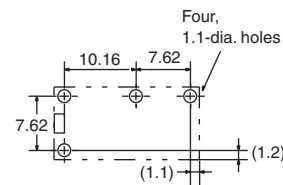

**G6B-1114C-US**  
**G6BU-1114C-US**

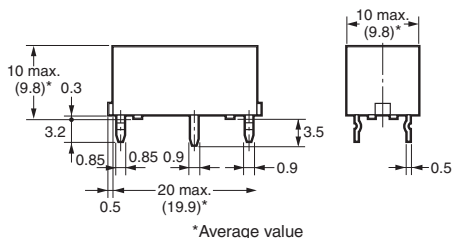
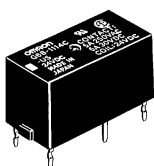

**G6BU-1114P, -1114C**

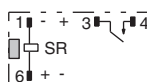

**G6BK-1114P-US**

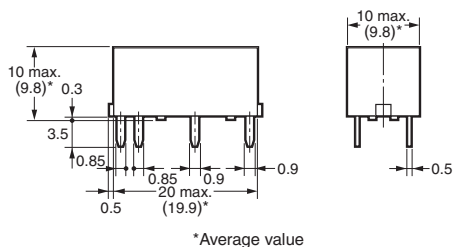
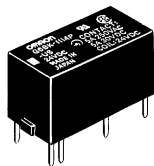

**Terminal Arrangement/Internal Connections (Bottom View)**  
**G6BK-1114P, -1114C**

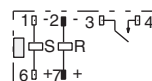

**Mounting Holes (Bottom View)**  
**G6BK-1114P, -1114C**

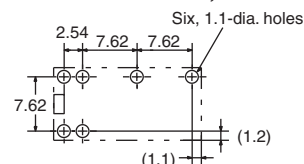

**G6BK-1114C-US**

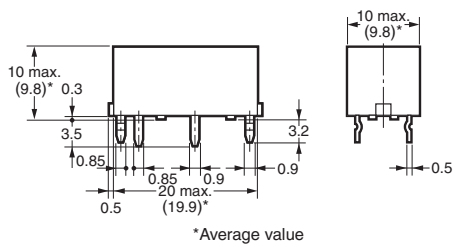
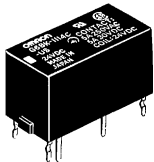

**G6B-1174P-US**

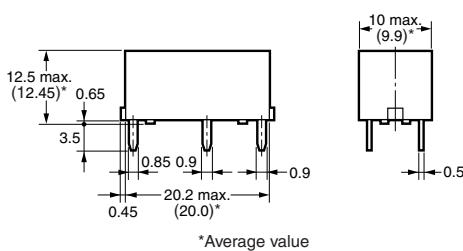
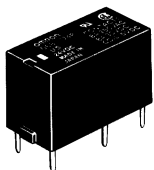

**Terminal Arrangement/Internal Connections (Bottom View)**  
**G6B-1174P, -1174C**

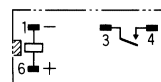

**Mounting Holes (Bottom View)**

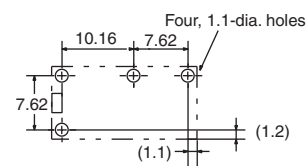

**G6B-1174C-US**

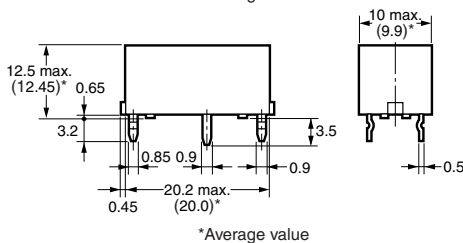
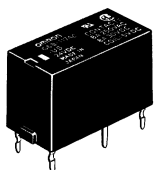

## Double Pole

G6B-2114P-US  
G6B-2214P-US  
G6B-2014P-US

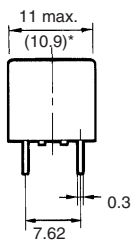
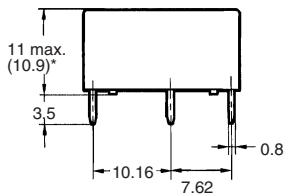
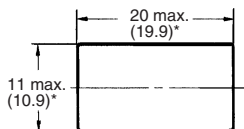
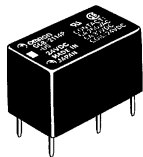

\*Average value

Terminal Arrangement/Internal Connections (Bottom View)

G6B-2114P-US

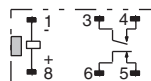

G6B-2214P-US

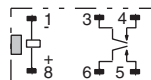

G6B-2014P-US

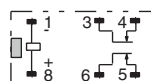

Mounting Holes (Bottom View)

Tolerance:  $\pm 0.1$

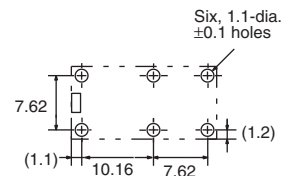

G6B-2114C-US  
G6B-2214C-US  
G6B-2014C-US

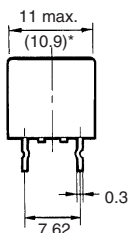
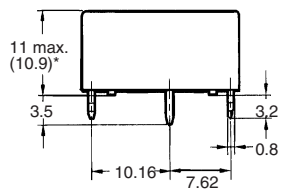
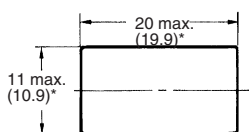
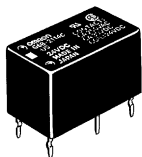

\*Average value

Terminal Arrangement/Internal Connections (Bottom View)

G6B-2114C-US

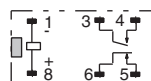

G6B-2214C-US

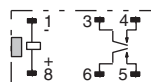

G6B-2014C-US

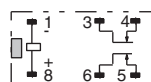

Mounting Holes (Bottom View)

Tolerance:  $\pm 0.1$

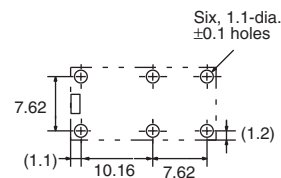

## Accessories

### Back Connecting Socket P6B-04P

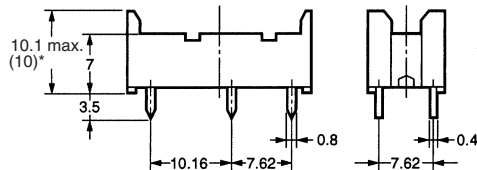
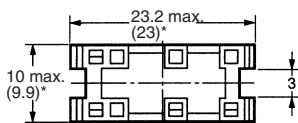
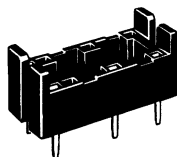

\*Average value

#### Mounting Holes (Bottom View)

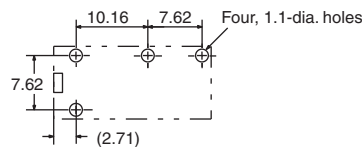

### P6B-06P

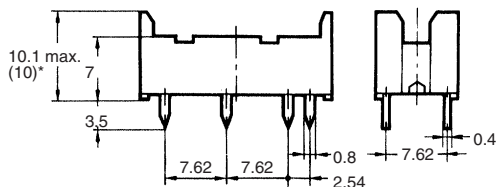
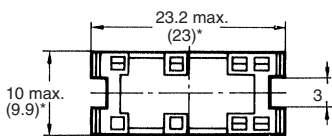
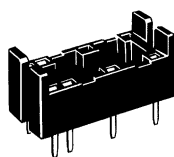

\*Average value

#### Mounting Holes (Bottom View)

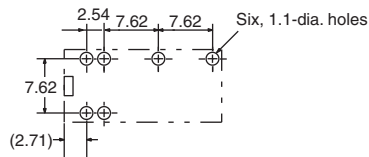

### P6B-26P

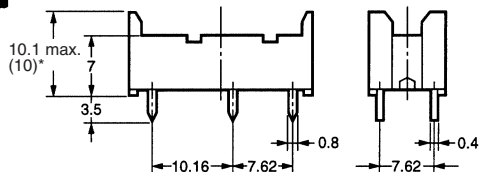
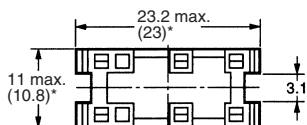
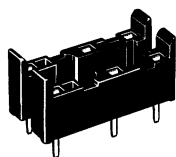

\*Average value

#### Mounting Holes (Bottom View)

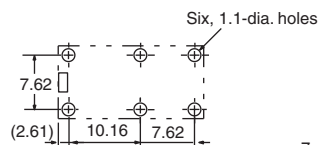

**Note:** Rated current of socket is 5 A max.

#### Mounting Height of Relay with Connecting Socket

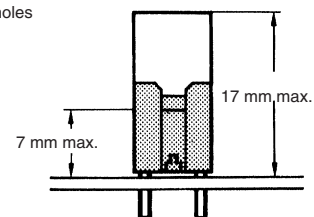

**Note:** Height of G6B-1174P-US is 19.5 mm max.

### Removal Tool P6B-Y1

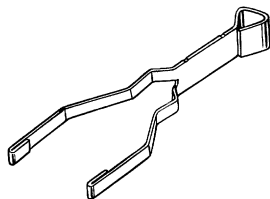

### Hold-down Clips P6B-C2

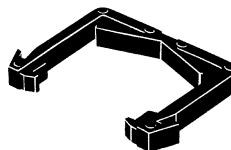

**Note:** P6B-C2 Hold-down Clips cannot be used for G6B-1174P-US.

All sales are subject to Omron Electronic Components LLC standard terms and conditions of sale, which can be found at [http://www.components.omron.com/components/web/webfiles.nsf/sales\\_terms.html](http://www.components.omron.com/components/web/webfiles.nsf/sales_terms.html)

**ALL DIMENSIONS SHOWN ARE IN MILLIMETERS.**

To convert millimeters into inches, multiply by 0.03937. To convert grams into ounces, multiply by 0.03527.

---

**OMRON**<sup>®</sup>

**OMRON ELECTRONIC  
COMPONENTS LLC**

55 E. Commerce Drive, Suite B  
Schaumburg, IL 60173

**847-882-2288**

**OMRON ON-LINE**

Global - <http://www.omron.com>

USA - <http://www.components.omron.com>

Cat. No. X301-E-1b

09/11

Specifications subject to change without notice

Printed in USA



# Mouser Electronics

Authorized Distributor

Click to View Pricing, Inventory, Delivery & Lifecycle Information:

## Omron:

[G6B-2114P-US-DC24](#) [G6B-2114P-1-US-DC24](#) [G6BK-1114P-US-DC5](#) [G6B-2114P-US-DC5](#) [G6B-2114P-US-DC6](#)  
[G6B-2214P-US-DC5](#) [G6B-2214P-US-DC12](#) [PYC-P](#) [G6B-1174P-US-DC24](#) [G6B-1114P-US-DC12](#) [G6B-1114P-US-](#)  
[DC24](#) [G6B-1174P-US-DC12](#) [G6B-1114P-1-US-DC24](#) [G6B-2214P-US-DC24](#) [PLE11-0](#) [P6B-04P](#) [G6B-1174P-US-](#)  
[DC5](#) [G6B-1114P-US-DC5](#) [G6B-2014P-US-DC12](#) [G6B-2114P-US-DC12](#) [G6BK-1114P-US-DC12](#) [G6B-1114P-1-US-](#)  
[DC12](#) [PT14-0](#) [P6B-26P](#) [P6B-06P](#) [G6B-1114C-US-DC12](#) [G6B-1114C-US-DC5](#) [G6B-1114P-1-US DC9](#) [G6B-1114P-](#)  
[1-US-DC5](#) [G6B-1114P-FD-US-DC12](#) [G6B-1114P-FD-US-DC5](#) [G6B-1114P-US-DC18](#) [G6B-1114P-US-DC3](#) [G6B-](#)  
[1114P-US-DC6](#) [G6B-1114P-US-DC9](#) [G6B-1114P-US-PS DC12](#) [G6B-1174P-1-US DC12](#) [G6B-1174P-1-US DC5](#)  
[G6B-1174P-1-US-DC24](#) [G6B-1174P-FD-US-DC5](#) [G6B-1174P-US-DC6](#) [G6B-1177P-ND-US DC24](#) [G6B-2014P-FD-US](#)  
[DC12](#) [G6B-2114C-US DC6](#) [G6B-2114P-1-US DC6](#) [G6B-2114P-1-US-DC9](#) [G6B-2114P-US-DC9](#) [G6B-2214P-1-US](#)  
[DC6](#) [G6B-2214P-FD-US DC24](#) [G6B-2214P-US DC9](#) [G6B-2214P-US-AP DC24](#) [G6BK-1114P-1-US DC5](#) [G6BK-](#)  
[1114P-1-US DC6](#) [G6BK-1114P-1-US-DC12](#) [G6BK-1114P-1-US-DC24](#) [G6BK-1114P-US-DC6](#) [G6BU-1114C-US-DC12](#)  
[G6BU-1114P-US DC3](#) [G6BU-1114P-US-DC24](#) [G6BU-1114P-US-DC5](#) [G6BU-1114P-US-DC6](#) [G6BK-1114P-US DC3](#)  
[G6B-1174P-FD-US-DC12](#) [G6B-1174P-FD-US-DC24](#) [G6B-2114P-1-US-DC12](#) [G6BU-1114P-US-DC12](#) [G6B-1114P-](#)  
[FD-US-DC24](#) [PTF11A](#) [G6BK-1114P-US-DC24](#) [PYF11A](#) [P6B-Y1](#) [G6B-1114P-1-US DC6](#) [G6B-1114P-US DC20](#)  
[G6B-1114P-US-AP DC5](#) [G6B-1174P-FD-US DC6](#) [G6B-2014P-US DC6](#) [G6B-2114P-US-AP DC12](#) [G6B-2114P-US-](#)  
[P6B DC24](#) [G6B-2214C-US DC12](#) [G6BK-1114P-1-US DC9](#) [G6B-2014P-US DC24](#) [G6B-2014P-US DC5](#) [G6B-2214P-](#)  
[US DC6](#) [G6B-1114C-FD-US DC12](#) [G6B-1174P-FD-US DC3](#) [G6B-1174P-US DC3](#) [G6B-2014C-US DC24](#) [G6B-](#)  
[2014P-US DC48](#) [G6B-2114C-US DC12](#) [G6B-2114C-US DC5](#) [G6B-2114P-1-US DC5](#) [G6B-2114P-FD-US DC12](#) [G6B-](#)  
[2114P-FD-US DC5](#) [G6B-2114P-US DC48](#) [G6B-2214P-1-US DC12](#) [G6B-2214P-1-US DC24](#) [G6B-2214P-1-US DC5](#)  
[G6B-2214P-US DC48](#) [G6B-1114P-US-AP DC12](#) [G6B-1114P-US-SV DC24](#)