

TA8217P

DUAL AUDIO POWER AMPLIFIER

TA8217P is dual audio power amplifier designed for the audio power amplifier of portable radio cassette tape recorder.

FEATURES

- High Output Power : $P_{out} = 2.5W$ (Typ.)
($V_{CC} = 9V$, $R_L = 4\Omega$, $f = 1kHz$, $THD = 10\%$)
- Soft Clip
- Built-in Thermal Shutdown Protection Circuit
- Wide Operating Supply Voltage Range
: $V_{CC} = 4.5 \sim 12V$ ($T_a = 25^\circ C$)

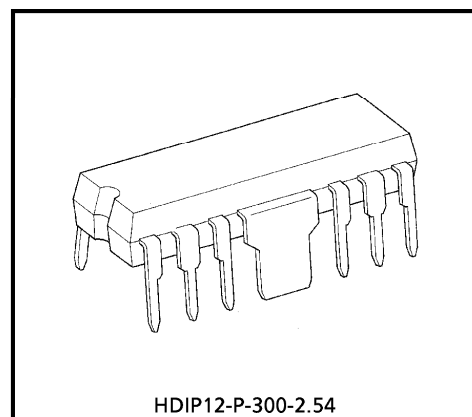

HDIP12-P-300-2.54
Weight : 1.4g (Typ.)

BLOCK DIAGRAM

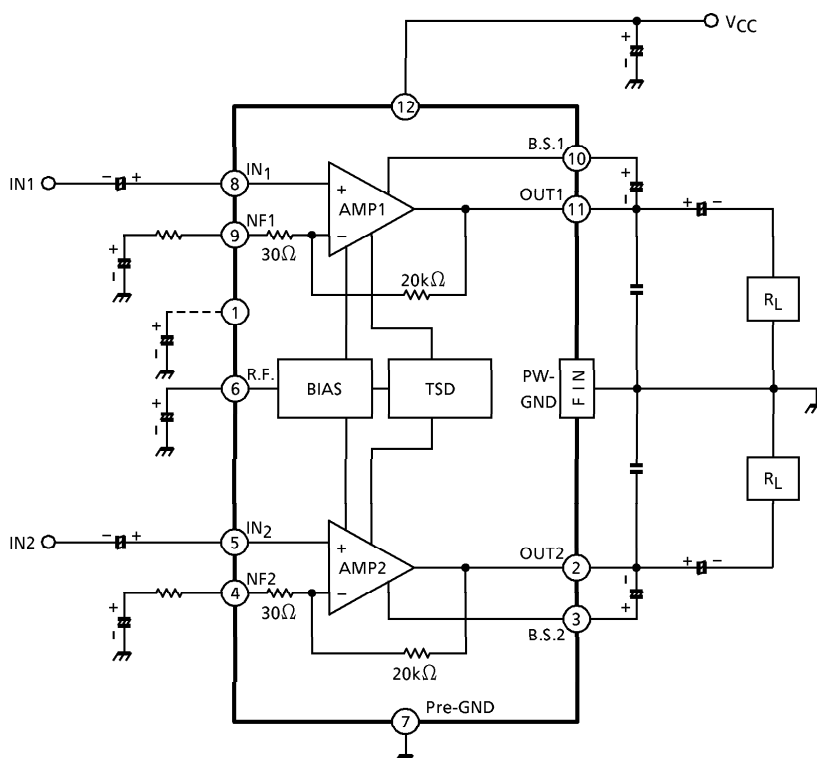

961001EBA2

● TOSHIBA is continually working to improve the quality and the reliability of its products. Nevertheless, semiconductor devices in general can malfunction or fail due to their inherent electrical sensitivity and vulnerability to physical stress. It is the responsibility of the buyer, when utilizing TOSHIBA products, to observe standards of safety, and to avoid situations in which a malfunction or failure of a TOSHIBA product could cause loss of human life, bodily injury or damage to property. In developing your designs, please ensure that TOSHIBA products are used within specified operating ranges as set forth in the most recent products specifications. Also, please keep in mind the precautions and conditions set forth in the TOSHIBA Semiconductor Reliability Handbook.

PRECAUTIONS FOR USE AND APPLICATION

(1) Input stage

The input stage of power amplifier is comprised of a PNP differential pair preceded by a PNP emitter follower which allows DC referencing of the source signal to ground. This eliminates the need for an input coupling capacitor. However, in case the brush noise of volume becomes a problem, provide serially a coupling capacitor to the input side.

(2) Adjustment of voltage gain

The voltage gain is fixed at $G_V \cong 56.5\text{dB}$ by the resistors (R_1 and R_2) in IC, however, its reduction is possible through adding R_f as shown in Fig.1. In this case, the voltage gain is obtained by the following equation.

$$G_V \cong 20 \log \frac{R_1 + R_2 + R_f}{R_1 + R_f}$$

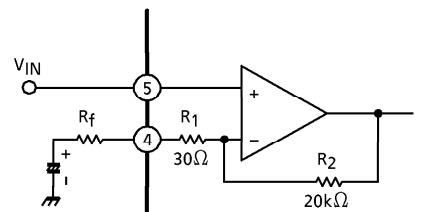

Fig.1

It is recommended to use this IC with the voltage gain of $G_V = 40\text{dB}$ or over.

(3) Measures against oscillation

For the capacitors C_6 and C_7 to be applied for preventing the oscillation between output terminal and GND, use the polyester film capacitor having superior quality in high frequency and temperature characteristics, however, since the characteristics of the capacitor may be different depending on the manufactures or kinds, apply the capacitor after confirmation.

Since the characteristics of the capacitor of the ceramic Type are liable to be affected by the temperature and the voltage, use the capacitor of larger capacity and be sure to perform the thermal test to check the oscillation allowance.

961001EBA2'

- The products described in this document are subject to foreign exchange and foreign trade control laws.
- The information contained herein is presented only as a guide for the applications of our products. No responsibility is assumed by TOSHIBA CORPORATION for any infringements of intellectual property or other rights of the third parties which may result from its use. No license is granted by implication or otherwise under any intellectual property or other rights of TOSHIBA CORPORATION or others.
- The information contained herein is subject to change without notice.

MAXIMUM RATINGS (Ta = 25°C)

CHARACTERISTIC	SYMBOL	RATING	UNIT
Supply Voltage	V _{CC}	20	V
Power Dissipation (Package Limitation)	P _D (Note 1)	4.0	W
Output Current	I _O	2.5	A
Operating Temperature	T _{opr}	-20~75	°C
Storage Temperature	T _{stg}	-55~150	°C

(Note 1) Value for mounting on PC board (Refer to P_D - Ta curve)

ELECTRICAL CHARACTERISTICS

(Unless otherwise specified, V_{CC} = 9V, R_L = 4Ω, R_g = 600Ω, f = 1kHz, Ta = 25°C)

CHARACTERISTIC	SYMBOL	TEST CIRCUIT	TEST CONDITION	MIN.	TYP.	MAX.	UNIT
Quiescent Current	I _{CCQ}	—	V _{in} = 0	—	23	55	mA
Output Power	P _{out} (1)	—	THD = 10%	2.0	2.5	—	W
	P _{out} (2)		THD = 10%, R _L = 3Ω	—	2.9	—	
	P _{out} (3)		THD = 10%, V _{CC} = 6V	—	1.0	—	
Total Harmonic Distortion	THD	—	P _{out} = 0.4W, G _v = 45dB	—	0.2	1.2	%
Voltage Gain	G _v (1)	—	R _f = 82Ω, V _{out} = 0.775V _{rms} (0dBm)	43	45	47	dB
	G _v (2)		R _f = 0, V _{out} = 0.775V _{rms} (0dBm)	—	56	—	
Cross Talk	C.T.	—	R _g = 600Ω, V _{out} = 0.775V _{rms} (0dBm)	—	-60	—	dB
Ripple Rejection Ratio	R.R.	—	R _g = 600Ω, V _{ripple} = 0.245V _{rms} (-10dBm) f _{ripple} = 100Hz	—	-52	-45	dB
Output Noise Voltage	V _{no}	—	R _g = 10kΩ, G _v = 45dB B _W = 20~20kHz	—	0.35	1.0	mV _{rms}
Input Resistance	R _{IN}	—	—	—	30	—	kΩ
Input Offset Voltage	V ₅ , V ₈	—	V _{in} = 0	—	20	—	mV

TYP. DC VOLTAGE OF EACH TERMINAL (V_{CC} = 9V, Ta = 25°C by test circuit)

TERMINAL No.	1	2	3	4	5	6	7	8	9	10	11	12
DC Voltage (V)	8.1	4.5	8.8	0.6	0.02	8.9	0	0.02	0.6	8.8	4.5	9.0

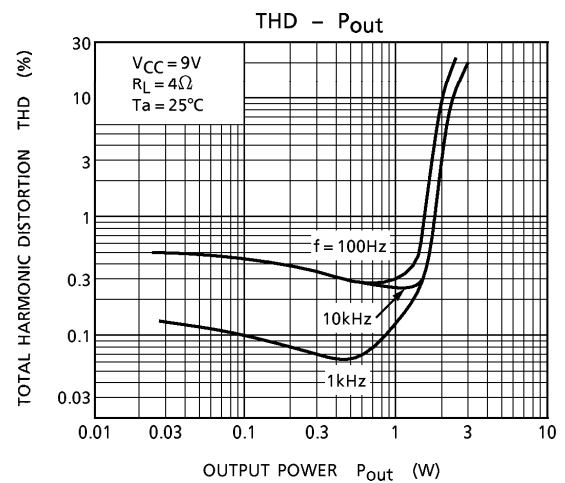
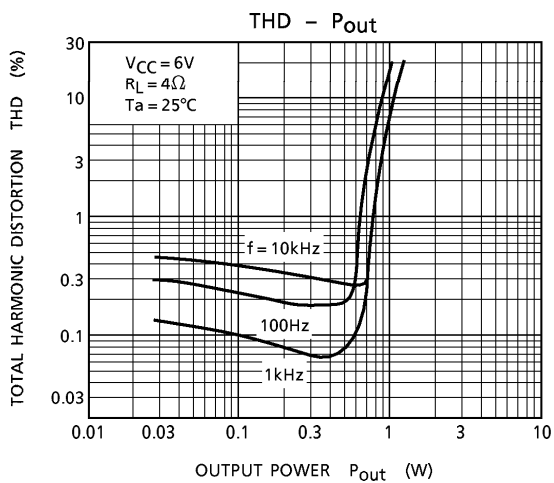
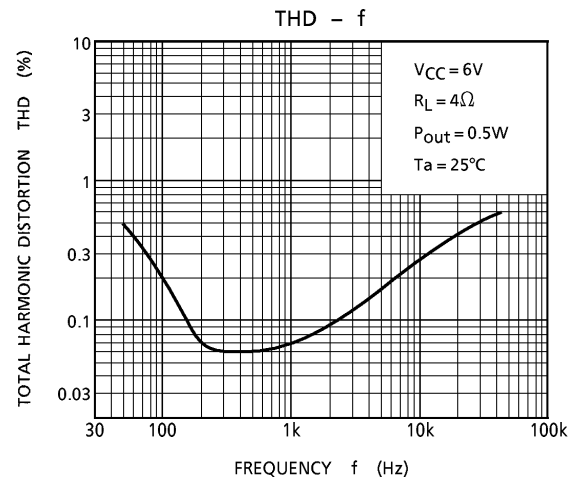
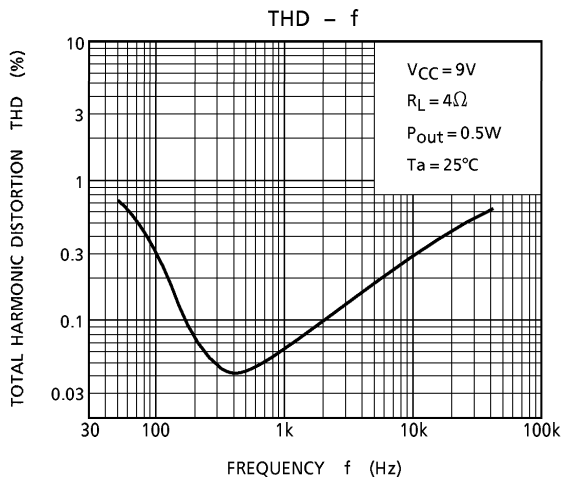
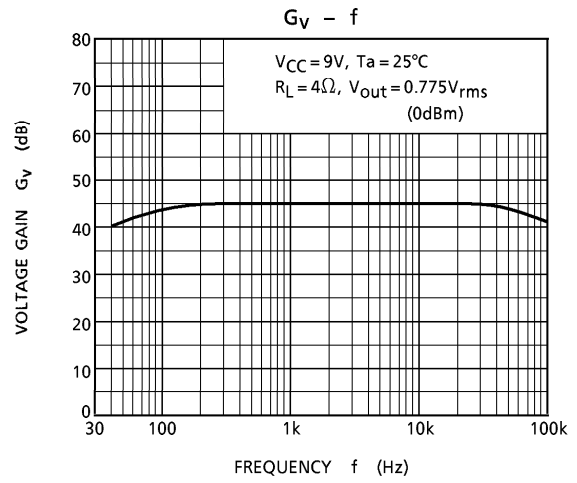
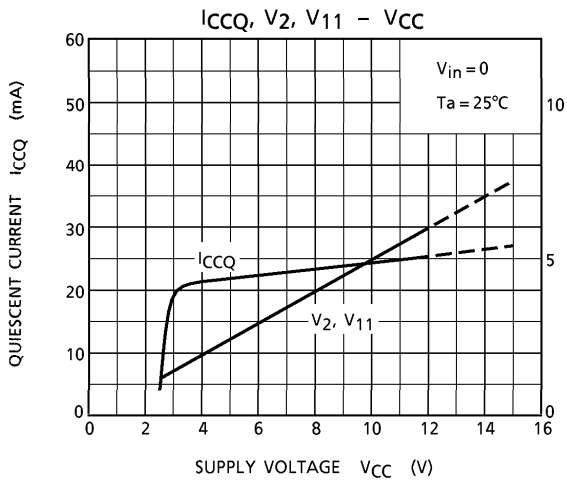

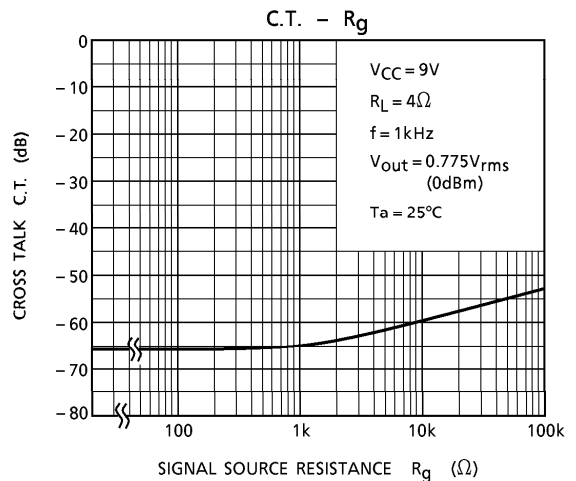
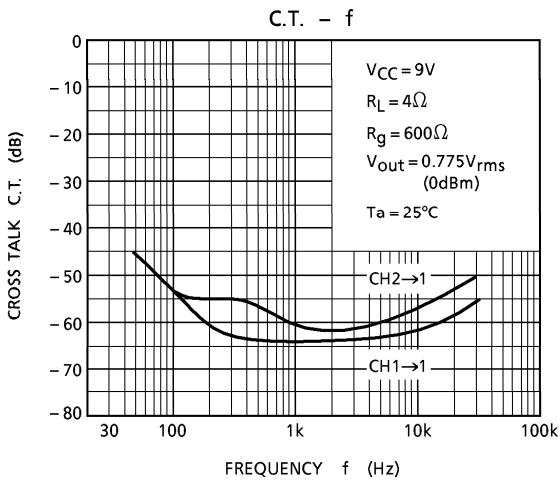
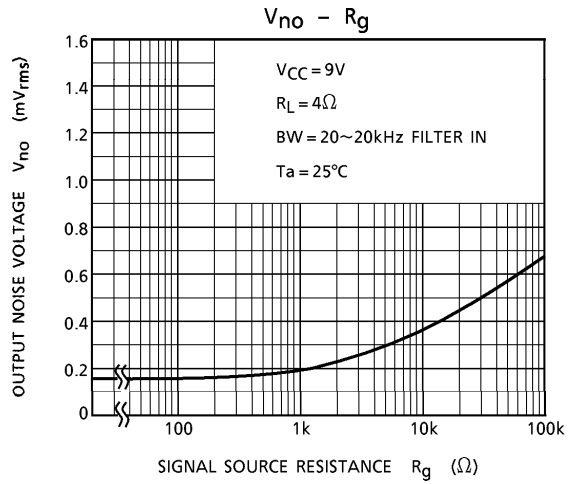
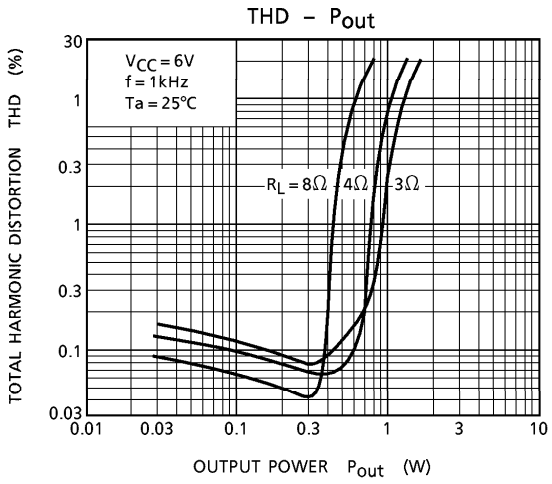
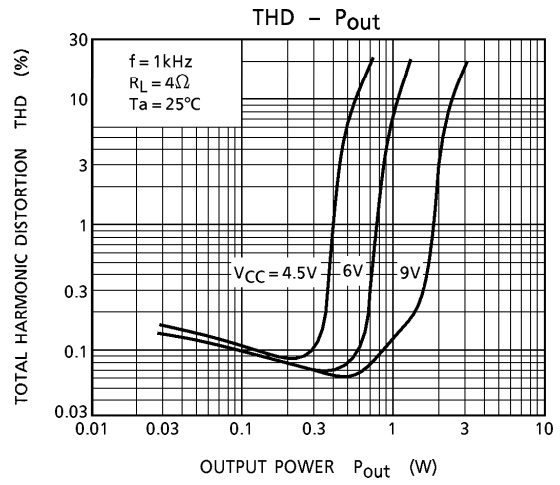
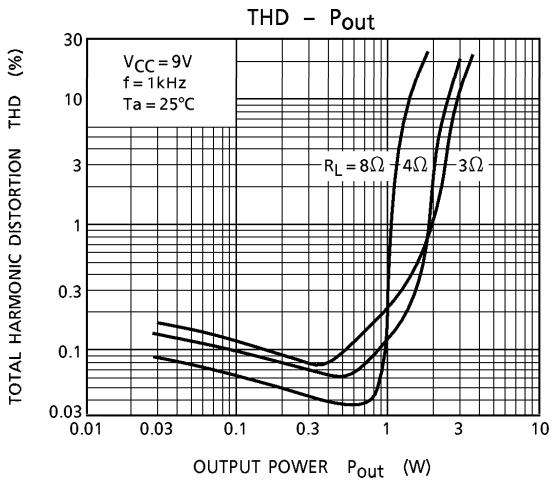

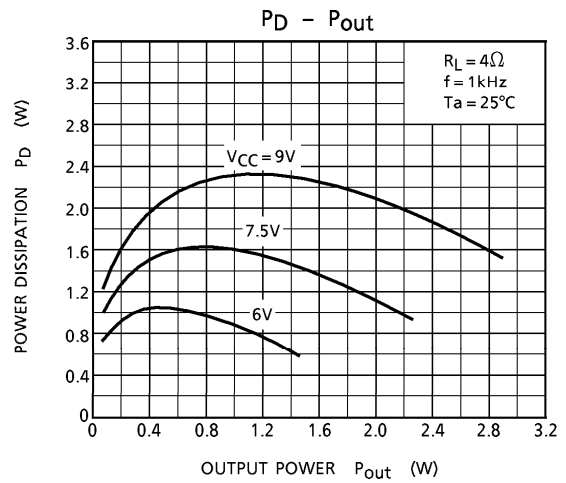
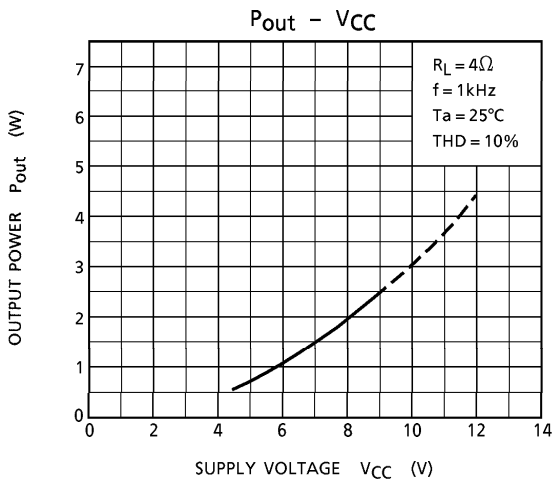
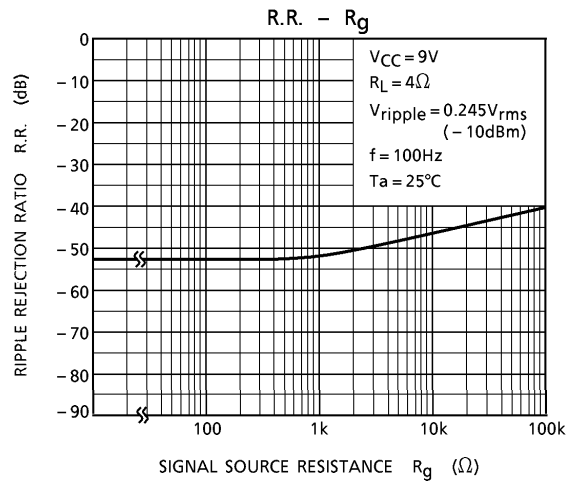
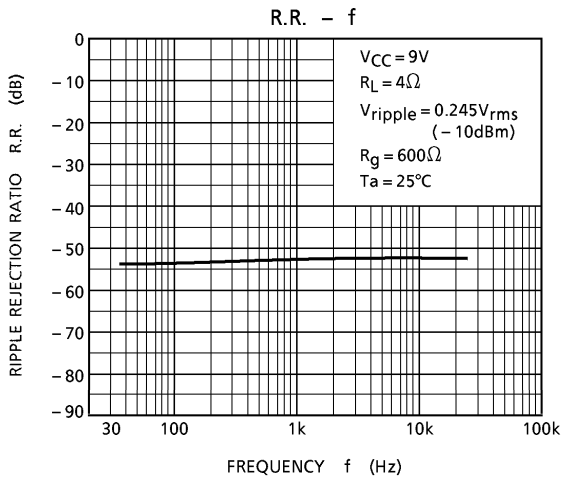

HEAT SINK

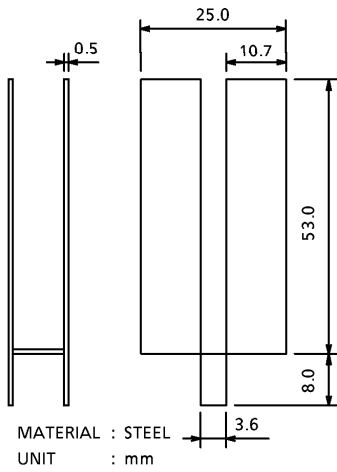

RECOMMENDED PCB LAYOUT

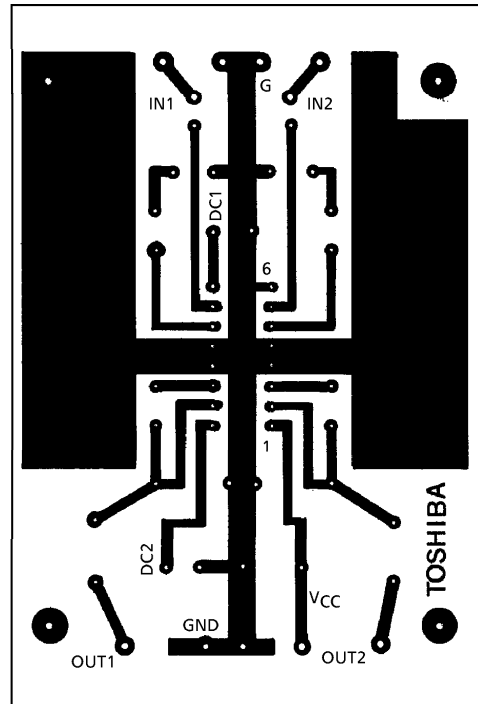

PCB : EPOXY GLASS
80mm × 60mm × 1.2mm

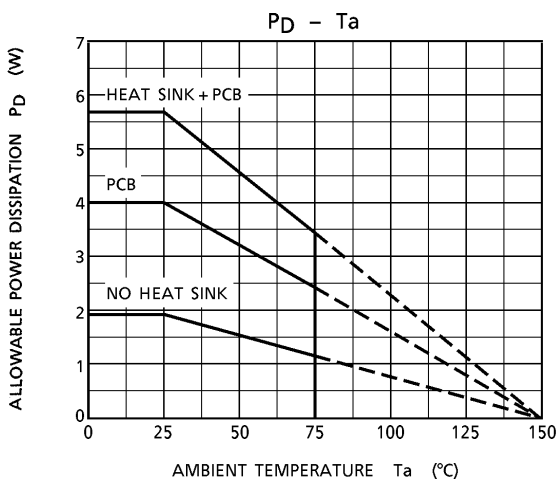

OUTLINE DRAWING
HDIP12-P-300-2.54

Unit : mm

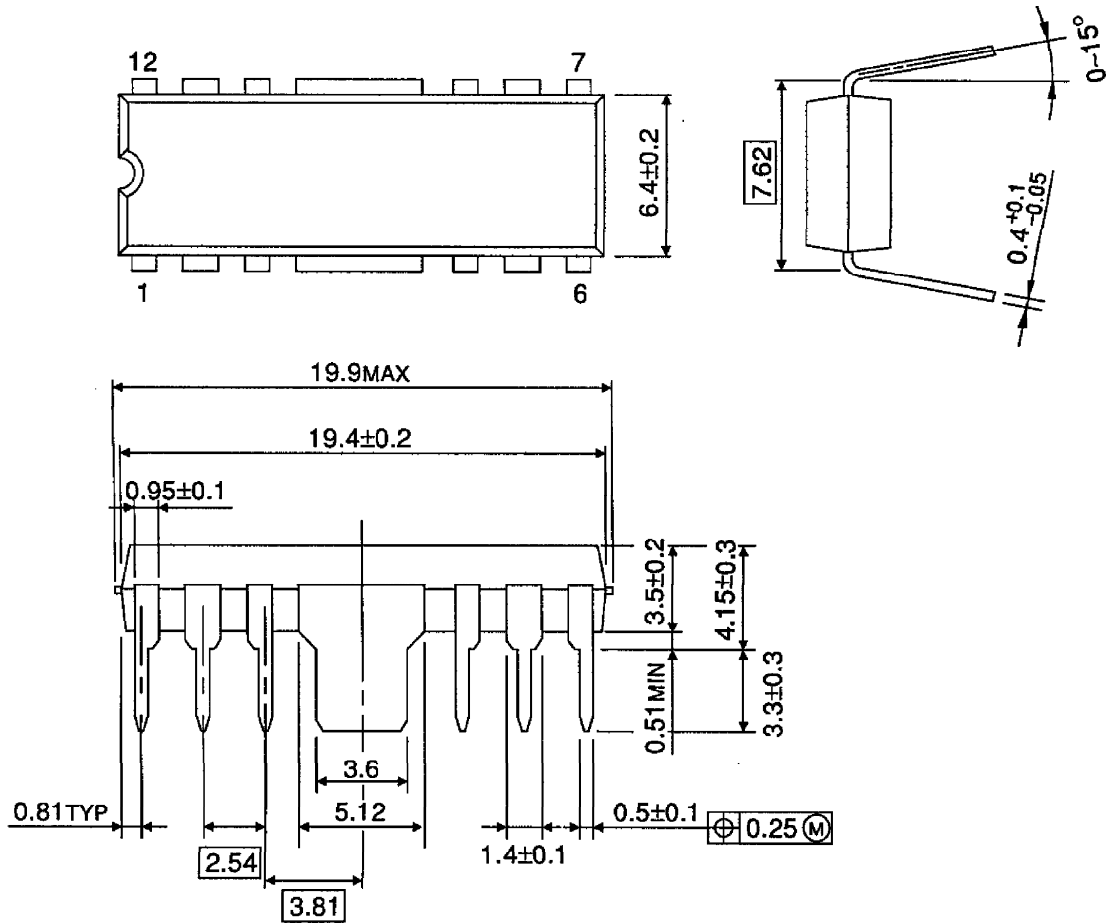

Weight : 1.4g (Typ.)